

Service  
Service  
Service



Philips Domestic Appliances and Personal Care

# Service Manual

## PRODUCT INFORMATION

- This product meets the requirements regarding interference suppression on radio and TV.
- After the product has been repaired, it should function properly and has to meet the safety requirements as officially laid down at this moment.

## TECHNICAL INFORMATION

- Power : 70 W
- Power consumption :
  - Cool down period average (KEG 23 °C -> 3 °C) : 0.068 kWh
  - Standby period (KEG on 3 °C) : 0.052 kWh
- Voltage : 100 - 120 V - 50/60 Hz  
200 - 240 V - 50/60 Hz
- Flow rate : 2 L per minute
- Contents Keg : 6 L
- Colour setting : Black/Metal
- SAP coding : HD3600/20

## OPTIONAL (accessories)

- No specific issues

For your safety first be sure the plug is disconnected from the mains!

**Rear case removal:**

- To remove the rear case, first remove the 4 screws.
- Open both doors, at the upper/lower right and left side the screws can be found..

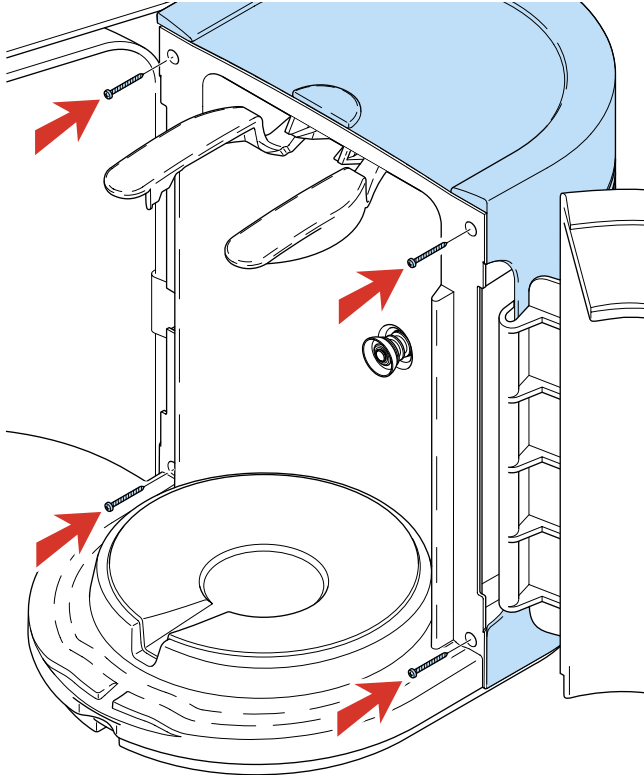

Picture 1.

- When the rear has been removed all parts can easy be reached.

**Replacing the Keg Connector Assembly:**

- The Keg connector assembly is very accurate outlined with assembly at production.
- This has been done to be sure all Kegs will fit easily without leakage to the machine.
- To be sure to place the new Keg connector assembly on the same spot, make the following precautions before unscrewing the Keg connector assembly.
- With a sharp screwdriver, scribe or marking tool you have to make a mark on the plastic, see picture for detail.
- When the mark has been carried out, you can unscrew the 4 posi screws and remove the Keg connector assembly.

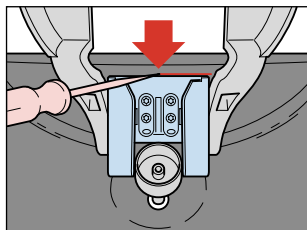

Picture 2.

- When reassemble the new Keg connector assembly, first connect the air pressure hose and then make sure that the new part will be outlined next to the marking you just made with the original part.

**Replacing the Display:**

- When the display has to be replaced for some reason, the complete Right door including display and flat cable has to be replaced.
- Remove the rear case assy, see rear case removal for details.
- Disconnect the flat cable connector from the main PCB that is coming from the right door.
- To re-assembly carry out steps backwards.

**Replacing the Fan assy:**

- When the Fan has to be replaced, unscrew the 4 posi screws and disconnect the connector of the Fan.
- When re-assemble the fan assy, be sure that the airflow (see arrow on the Fan) is appointing to the heatsink.

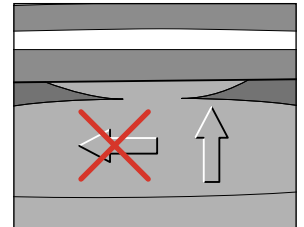

Picture 3.

\* Note when the Fan became defect also Peltier element has to be replaced or fully checked on performance. Due to overheating also the Peltier element will be damaged.

**Replacing the Peltier element:**

- When the Peltier element has to be replaced, first remove the rear case assy and Fan assy.
- Unscrew the 2 screws located on the heat sink.
- The heat sink including Peltier element can now be removed.
- With a small screwdriver the Peltier element can be removed from the heat sink, some force maybe needed.
- Before placing the new Peltier element, provide heat sink paste on both side of the Peltier element.
- Place the new Peltier element on the cooler plate on the same position of the removed Peltier element.

**NOTE!** It is important to place the Peltier element with the right side on the cooler plate.

- The cooler plate is the aluminium part fixed in the appliance, where the KEG will be cooled on.
- The heat sink is the aluminium part where the fan is assembled on.
- In other words, the cooling side of the Peltier has to point to the cooler plate and the warm side has to point to the heat sink.

- Details to check are:

- Soldered joints must be pointing to the cooling plate. (when Peltier is placed on the cooler plate the soldered joints are not visible, seen from the backside)
- Colours of wires must be equal positioned see, picture for detail.

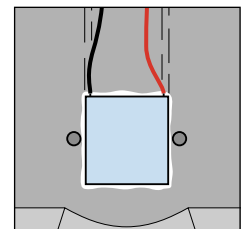

Picture 4.

- Be careful and make sure the Peltier element is well placed.
- Now the heat sink can be placed on the peltier element.
- Tighten the screws alternate, to prevent damaging the Peltier element for mounting lop-sided.
- **Maximum force that maybe applied to tighten the screws are: 0.6 Nm.**

**Replacing pressure sensor PCB:**

- To replace the pressure sensor PCB assy, situated on the pump, unscrew the 2 screws completely.
- Disconnect the connector, gently turn the PCB assy left and right and at the same time pull the unit up.
- Place the new PCB assy and check if the small rubber ring on the sensor tube is on its place.

**Replacing the pump unit:**

- Start with disconnecting the air pressure hose and electrical connections.
- Unscrew the 3 screws from the plastic bracket were the pump unit is hanging on.
- To re-assembly carry out steps backwards.

**NOTE!** To prevent leakage at the connection side of the hose, cut a small piece off the end of the hose.

Electrical circuit:

- When the appliance does not work, check the electrical circuit.

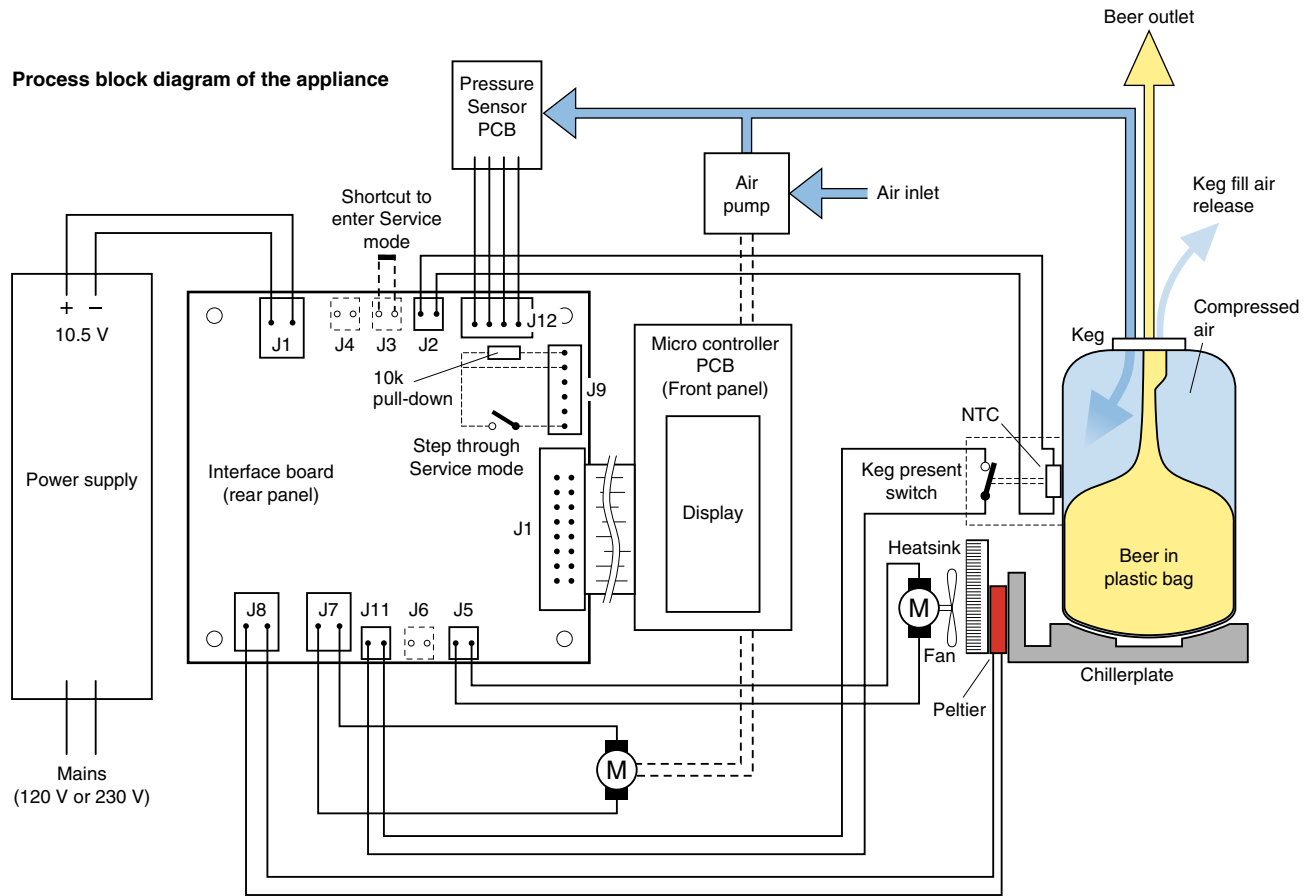

Picture 5.

Working principle of the appliance

- To understand the appliance better hereby a short description of the working principle.
- Beer, the Beer is stored in a plastic bag inside the Keg, see picture 5.
- The Beer only comes in contact with the tube connector and never with the appliance.
- When the tap unit and tube connector are connected on the Keg and the Keg is placed in the appliance, the Keg present switch will be activated.
- Once the appliance is activated after approximately 10 seconds you will hear a pump running.
- The task of this pump is to fill the space between the plastic bag and the walls of the Keg with air and create an overpressure situation (Overpressure  $\pm 1500$  mBar).
- Through the over pressure around the plastic bag (comparable like you squeeze into the plastic bag) the Beer will be pressurized (sort of) as well.
- By pulling the tap handle the tube connector hose will become opened and the Beer will flow out of the plastic bag via the tube connector in to the glass.
- After this cycle the pump will start running to go back into the overpressure situation like described before.
- When the Keg present switch has been actuated also the cooling process (Peltier element) will be started and display functions will become visible.
- The temperature will be measured by a NTC located in the Keg present plunger and indicated on the display.
- The volume indication measurement is based on the principle of a pressure drop measurement, measured by a pressure sensor.
- When pouring Beer, the pressure in the KEG will decrease, the amount that the pressure will decrease in a period of time will be calculated through the system.
- The result of this calculation will be indicated on the display.
- The volume indication steps are divided in 4 steps of 25 %.

**Service testroutines**

- This appliance has been equipped with special service routines to be able to check several functions of the appliance.
- Below the necessary steps will be described to enter into the service mode.
- Please follow the instructions carefully to avoid damaging the electronic circuit of the appliance.



**Putting the appliance into Service mode.**



1. Disconnect the appliance from mains.
2. Remove the keg.
3. Shortcut connector J3. (see picture 5)
4. Connect a simple push button to connector J9.
5. Connect the appliance to mains.

**Stepping through the Service mode.**

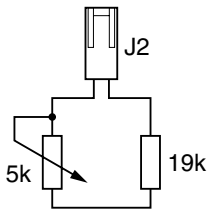
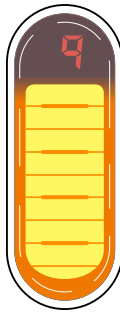
- As the Service Mode is entered, the display will show the software version, Service Mode 0.
- Every time the push button is activated, the next Service Mode is entered, forcing another part of the appliance to become active. The list below shows all the possible Service Modes.
- After mode 10, the routine jumps back to mode 1.

Mode	Test	Stimulus	Response	Remark
0	No test		Shows software version	2 digits. E.g. 20 = version 2.0
1	Display test		1. Display shows red 1 2. Display blanks 3. All segments on (red) 4. All segments on (green) 5. Repeat from 2.	Segment test runs automatically
2	Pump motor		1. Pump motor starts running. 2. Display shows red 2.	Pump runs; Voltage across pump: ~9 Vdc / ~2.7 Vrms
3	Fan motor high level		1. Fan starts running. 2. Display shows red 3.	Fan runs on high level (100%) Voltage across fan: ~10.5 Vdc / ~0 Vrms
4	Fan motor low level		1. Fan starts running. 2. Display shows red 4.	Fan runs on low level (~75%) Voltage across fan: ~8.9 Vdc / ~0.25 Vrms
5	Peltier low		1. Peltier starts cooling. 2. Display shows red 5.	Peltier runs on low level (~10%) Voltage across Peltier: ~2.3 Vdc / ~3.0 Vrms Current through Peltier: ~2.3 Arms (Fan keeps running at high level)
6	Peltier medium		1. Peltier starts cooling. 2. Display shows red 6.	Peltier runs on medium level (~50%) Voltage across Peltier: ~6.0 Vdc / ~4.0 Vrms Current through Peltier: ~4 Arms (Fan keeps running at high level)
7	Peltier high		1. Peltier starts cooling. 2. Display shows red 7.	Peltier runs on high level (100%) Voltage across Peltier: ~10.5 Vdc / ~0.0 Vrms Current through Peltier: >4.7 Arms (lower = defect Peltier) (Fan keeps running at high level)
8	Pressure measurement	Connect dummy pressure sensor	1. Display shows full bar, graph if ok. 2. Display shows red 8.	Replace pressure sensor by dummy sensor
9	Temperature measurement	Connect dummy NTC sensor	1. Display shows full bar, graph if ok. 2. Display shows red 9.	Replace NTC sensor by dummy sensor
10	Keg Activation switch	Operate the Keg Activation switch	1. Bar graphs off (not activated) or on (activated). 2. Display shows red 10.	

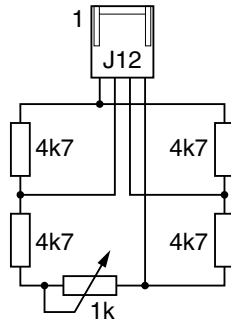
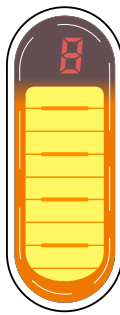
<b>NTC DUMMY:</b>	
	
NTC value $20\text{ k}\Omega < R_{\text{dummy}} < 22\text{ k}\Omega$ (= 4 °C ... 6 °C)	Any other value:
	

<b>PRESSURE SENSOR DUMMY:</b>	
	
Input voltage $9\text{ mV} < V_{\text{dummy}} < 10\text{ mV}$ (900 ... 1100 mbar)	Any other value:
	

Trouble shooting:

1. Appliances doesn't work at all

Check if the **KEG PRESENT** switch is functioning OK or check the Voltage output (10 V ± 0.5 V) of the Power supply.

2. Display Error signals

If somehow the system detects a problem, in a few occasions the system is able to use the display for displaying the type of error detected by the system.

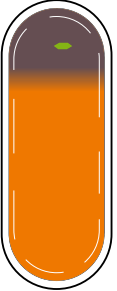
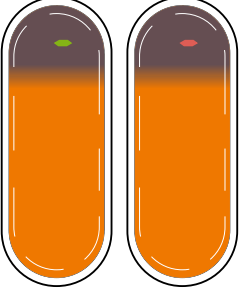
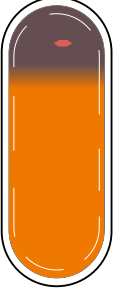
	<p><b>DISPLAY no tap unit</b></p> <p>Static segment green Background lights on Bar graphs off</p>	<p>Way of software detection: When the system detects no pressure rise during running of the pump (duration measurement 10 seconds), the software will interpret that there is no tap unit on its place.</p> <p>Checks:</p> <ul style="list-style-type: none"> <li>• Is the pressure sensor function correctly? (See chapter repair instructions, service test routines to check with dummy)</li> <li>• Is a huge air leakage noticeable in the system?</li> </ul>
	<p><b>DISPLAY leakage</b></p> <p>Static segment green or red. Blinking background Bar graphs off</p>	<p>Way of software detection: When the system detects a pressure fall which is greater than normal occur when pouring Beer, the software will interpret that there is a leakage in the system. Measurement take approximately 300 seconds.</p> <p>Checks:</p> <ul style="list-style-type: none"> <li>• Is the pressure sensor function correctly? (See chapter repair instructions, service test routines to check with dummy)</li> <li>• Is a huge air leakage noticeable in the system?</li> </ul>
	<p><b>DISPLAY no keg</b></p> <p>Static segment red Background lights on Bar graphs off</p>	<p>Way of software detection: The KEG present/activation switch will give input to the Interface board.</p> <p>Checks:</p> <ul style="list-style-type: none"> <li>• Is the micro switch function correctly? (See chapter repair instructions, service test routines to check the switch in combination with interface board)</li> </ul>

3. Blinking display or pump is “to” often activated. (Air Leakage)

If the display is blinking or the complaint is that the pump is running very often (more than 4 times per hour without pouring Beer), the cause could be that there is air leakage in the air pressure system.

Possible components to check are Keg, tube connector, tap unit, pump, hose or pressure sensor.

Checking the problem to determine if the leakage is located inside the appliance or outside.

Step 1: **Remove** the Keg and tap unit.

Step 2: **Block** the air Inlet coupling at the Keg side.

See picture for location, be sure the hole is **blocked**.

Step 3: **Actuate** the KEG present switch (for example putting a Keg without tap unit in the appliance) after ± 10 seconds the pump will start running)

When the pump has stopped, wait ± 300 seconds after this time has passed, check if the display reading is normal (not blinking) also the pump may not run in this period of 300 seconds.

When the system has detected a air leakage by itself, the backlight of the display starts blinking. (see also point 2, Display error signals for details)

When the system is function correctly and there is absolutely no air leakage the pump runs two or three time per 24 Hours.

Possible root causes that have to be checked are, tube connector, Keg, tap unit and connections.

If the pump keeps pumping or the system is displaying a leakage error, other internal root causes to be checked are, leakage at connections of hose and components, pressure sensor leaks or is electronically defect **see chapter repair instructions, service test routines step 8 to check the electronic parts.**

Leakage problems can be found by providing a little bit water and soap on the suspected places to see if the air bells are visible when the pump is activated.

When internal no failures are found please check the external parts like KEG, tap unit and tube connector.

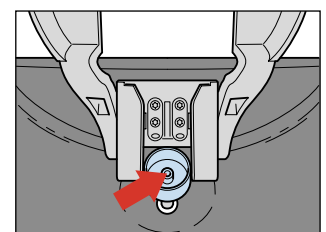

Picture 6.

#### 4. Cooling problems.

Several causes can influence the unit from cooling down.

**Cool down process takes very long. (more than 18 hours KEG 23 °C -> 3° C)**

- Check the usage conditions; the cooling principle of the appliance is based on a Peltier element. The Peltier element works by withdrawn heat that results in the fact that the surface on the other side of the element will cool down. To be sure the Peltier element is doing it's job well it is very important that the airflow from the fan that transports the produced warmth out of the appliance is free ( $\pm 10$  cm) space around the appliance.
- Check if the ambient temperature did not exceed 27 °C.
- Check if the fan is turning well and there is no blockage caused by dust or other particles.
- Check if the Fan is correct placed (see chapter DISASSEMBLY- AND RE-ASSEMBLY ADVISE, replacing the Fan assy for details).

**Unit doesn't cool down.**

Probable root causes:

- Peltier element became defective.  
(see chapter repair instructions, service test routines steps 5 - 7 to check the electronic parts)
- Temperature Sensor is filthy or defective were through the cooling control process is derangement.  
(see chapter repair instructions, service test routines step 9 to check the electronic parts)
- Display temperature reading is not reliable. (To check the display reading, place a temperature sensor next to the location of the KEG present plunger, after  $\pm 5$  minutes of stabilization check the temperature reading from the display with the external temperature measurement device.  
Because the temperature sensor is placed in the middle of the KEG, **subtract a 4.2 °C** from the external placed temperature meter before judging the values.  
After subtraction of 4.2 °C, deviation aloud  $\pm 1^\circ$  C, below  $3^\circ$  C  $-1^\circ$  C /  $+2^\circ$  C)

**Example:**

**External indication temperature meter 7.2 °C**

**Display reading PerfectDraft system 3 °C**

**Conclusion (7.2 reading ext. - 4.2 offset value) = 3 °C, appliance within spec.**

#### 5. Beer leakage.

If the consumer complains about Beer leakage, most probably items that have to be checked are Keg, tube connector and tap unit.

If the Beer leakage is noticed at the spout side, please check the tube connector on presence of hair-line cracks or check if the tube connector is good positioned.

Other possibility could be that the closing mechanism of the tap unit does not block the Beer tube accurate.

If the Beer leaks more at the Keg or tap unit position, please check the Keg, tube connector or tap unit on visual aspects.

#### 6. Condensation water leakage.

When the consumer complains about Beer/water under the appliance most probably cause is that either the drip tray unit was not good placed under/against the appliance or the drip tray was not emptied on time, which can cause overflow of a mix of Beer and water.

Other possibility could be that the doors were not closed properly.

#### 7. Temperature display reading cannot be trust.

If the Display reading is not trustful or values are displayed that are not in line with what maybe expected, the display reading has to be checked.

For checking the temperature reading please see under **Trouble shooting point 4 Cooling problems** or to determine if the temperature sensor or circuit board has become defect, please see **chapter repair instructions, service test routines step 9 to check the electronic parts.**

It is not possible to adjust the temperature measuring system of the appliance.

8. Beer volume indication.

The Beer volume indicator is a device to give the consumer an impression about the amount of Beer left in the KEG.

This indicator is not accurate only steps of 25 % are possible to display.

When the consumer is complaining about the fact that the display indicates a empty KEG but there is still Beer left in the KEG this is actually not a failure in the appliance.

When less then 30 % of the volume is measured by the system the display will indicate 0 %.

Other complaints of the consumer could be that the display shows 100 % volume, but there is already Beer out of the KEG.

If for some reason the appliance has been **switched off** or a **voltage dip** has occurred in the mains network or the **KEG has been removed** and replaced again, the system will start with a **100 % volume indication**.

After pouring one or two glasses of Beer, the volume indication will be recalculated and displayed.

If the volume indication is for some reason not thrust full, the cause could be that there is an air leakage in the system.

In that case most likely parts to check are Beer **tube connector**, **KEG** or **Adaptor**. See under **Trouble shooting point 3 Blinking display or pump is “to” often activated**. (Air Leakage).

9. No foam on the Beer.

If the complaint is that there is “almost” or no foam on the Beer, the following have to be checked.

- 1) Temperature of the Beer must be below 9° C, check DFU for more tips.
- 2) Glasses have to be clean, check DFU for more tips!
- 3) Beer tube connector is not properly installed or is damaged, check DFU for more tips.
- 3) There must be no air leakage in the system.

(Trouble shooting point 3 Blinking display or pump is “to” often activated. (Air Leakage).

Pos	Service code	Description
1	9965 000 26106	Rear case assy
2	9965 000 26113	Left Door/display assy
3	9965 000 26114	Right Door assy
4	9965 000 26107	Steelplate driptray
5	9965 000 26108	Baseplate Driptray
6	9965 000 26121	Handle assy
7	9965 000 26122	Handle O-ring
8	9965 000 26124	Spout O-ring
9	9965 000 26123	Spout
10		Tube connector
11	9965 000 26126	O-ring 11X2 Air inlet side
12	9965 000 26125	Tap unit
13	9965 000 26129	Connector/Lever assy
14	9965 000 26130	Air coupling
15	9965 000 26127	Sensor assy
16	9965 000 26128	Skirt
17	9965 000 26115	Grommet. Pump position
18	9965 000 26116	Pump assy
19	9965 000 26131	Seal
20	9965 000 26117	Pressure sensor PCB assy
21	9965 000 26118	Pressure hose assy
22	9965 000 26120	Power supply HV 220-240V
23	9965 000 26112	Main PCB
24	9965 000 26119	Peltier assy
25	9965 000 26111	Micro switch assy
26	9965 000 26110	Grommet, FAN position
27	9965 000 26109	Fan assy

